

Description: _____

Qty: _____

Finish: _____

custom post rail

PROPRIETARY AND CONFIDENTIAL
THE INFORMATION CONTAINED IN THIS DRAWING IS THE SOLE PROPERTY OF PRL GLASS SYSTEMS. ANY REPRODUCTION IN PART OR AS A WHOLE WITHOUT THE WRITTEN PERMISSION OF PRL GLASS SYSTEMS IS PROHIBITED.

REV.

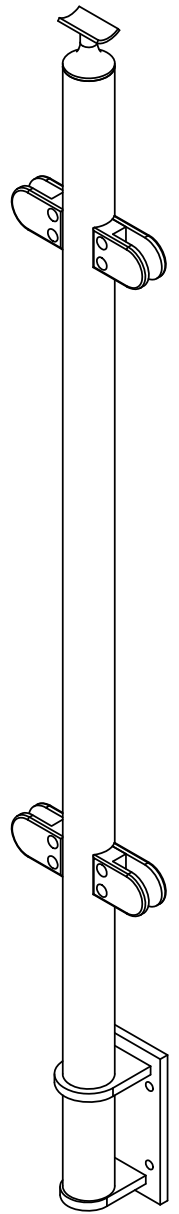
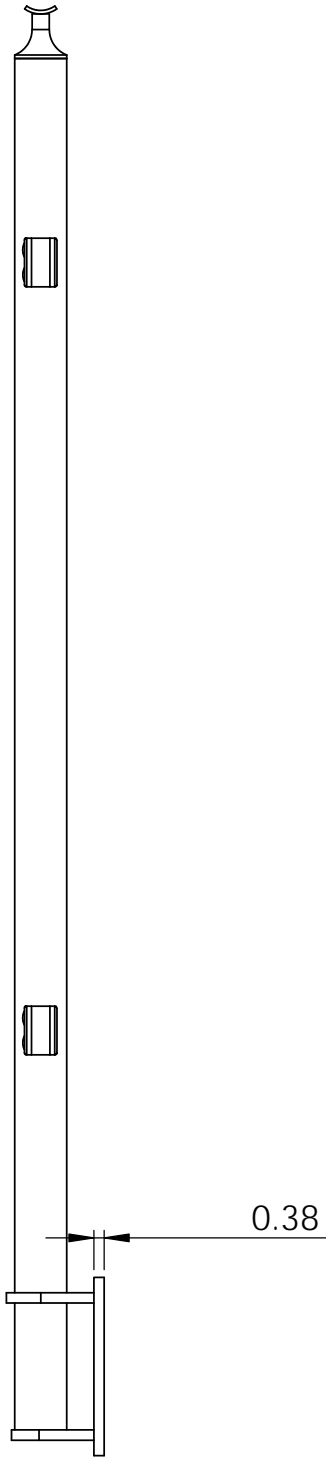
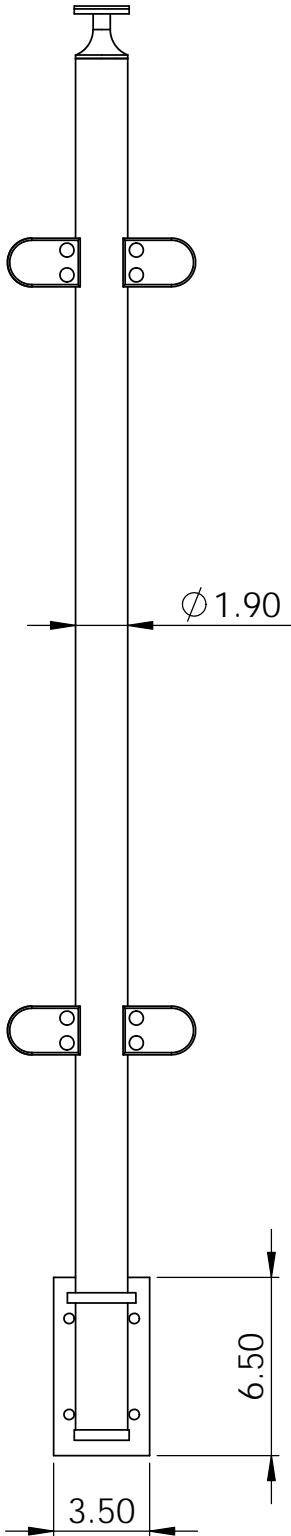
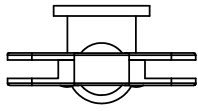

Description: _____

Qty: _____

Finish: _____

custom post rail

PROPRIETARY AND CONFIDENTIAL
THE INFORMATION CONTAINED IN THIS DRAWING IS THE SOLE PROPERTY OF PRL GLASS SYSTEMS. ANY REPRODUCTION IN PART OR AS A WHOLE WITHOUT THE WRITTEN PERMISSION OF PRL GLASS SYSTEMS IS PROHIBITED.

REV.



Description: _____

Qty: _____

Finish: _____

custom post rail

PROPRIETARY AND CONFIDENTIAL
THE INFORMATION CONTAINED IN THIS DRAWING IS THE SOLE PROPERTY OF PRL GLASS SYSTEMS. ANY REPRODUCTION IN PART OR AS A WHOLE WITHOUT THE WRITTEN PERMISSION OF PRL GLASS SYSTEMS IS PROHIBITED.

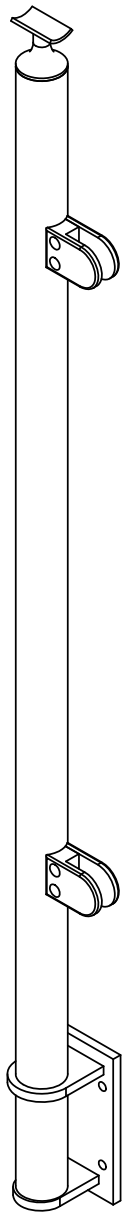
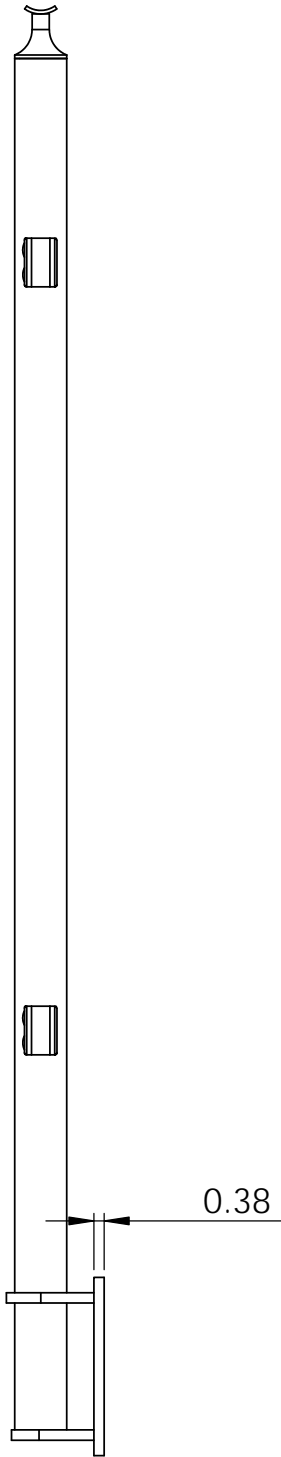
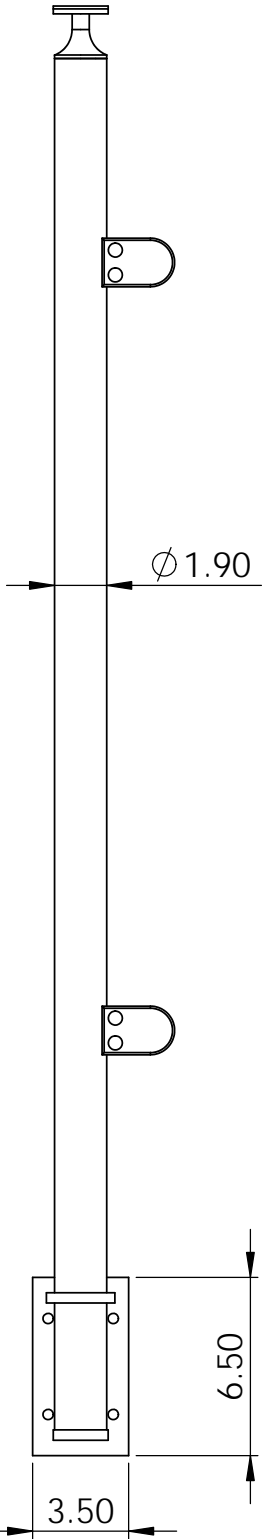
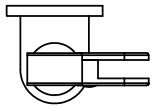

Description: _____

Qty: _____

Finish: _____

custom post rail

PROPRIETARY AND CONFIDENTIAL
 THE INFORMATION CONTAINED IN THIS DRAWING IS THE SOLE PROPERTY OF PRL GLASS SYSTEMS. ANY REPRODUCTION IN PART OR AS A WHOLE WITHOUT THE WRITTEN PERMISSION OF PRL GLASS SYSTEMS IS PROHIBITED.

REV.

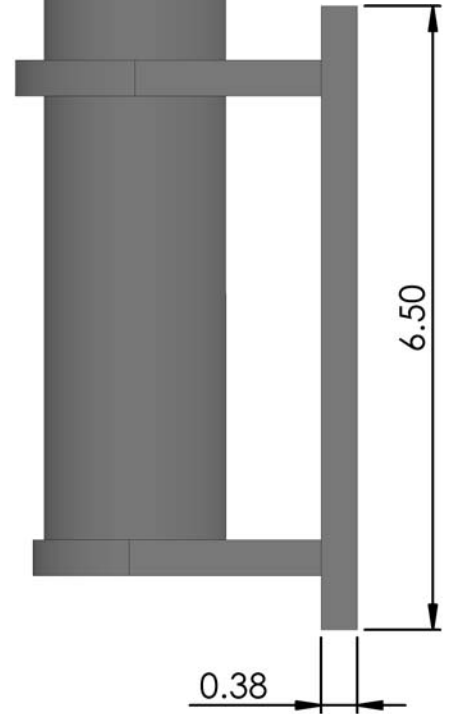
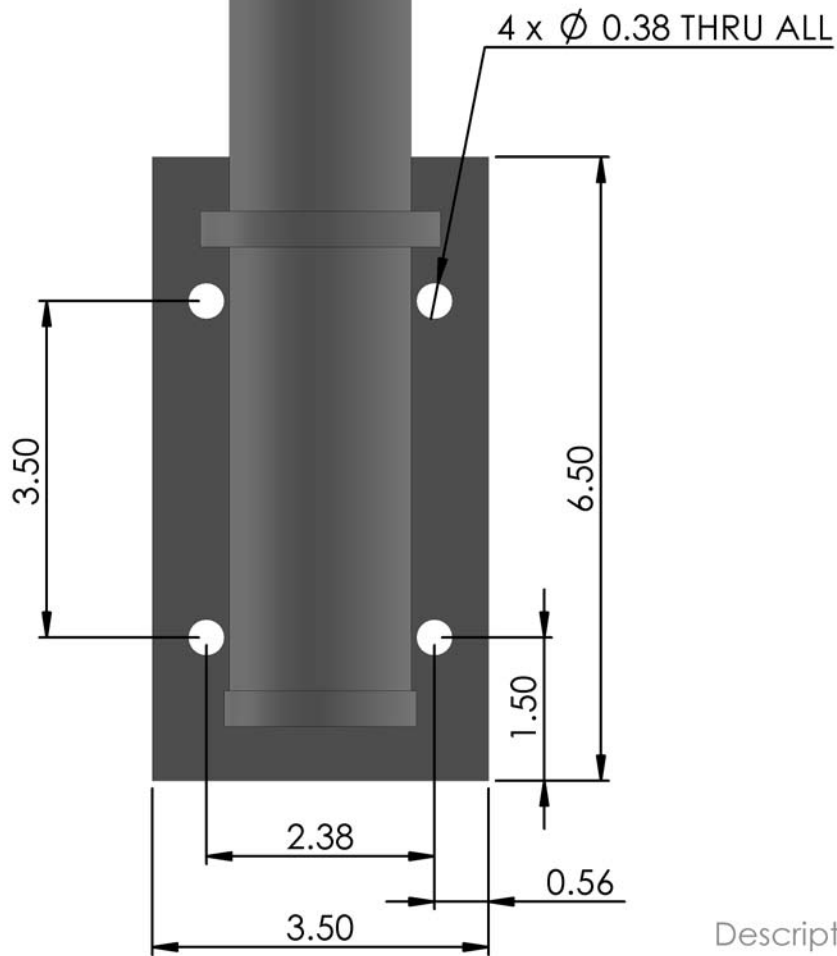

Description: _____

Qty: _____

Finish: _____

custom post rail

PROPRIETARY AND CONFIDENTIAL
THE INFORMATION CONTAINED IN THIS DRAWING IS THE SOLE PROPERTY OF PRL GLASS SYSTEMS. ANY REPRODUCTION IN PART OR AS A WHOLE WITHOUT THE WRITTEN PERMISSION OF PRL GLASS SYSTEMS IS PROHIBITED.

REV.